

Article number: 0129030

Description: Circlip RB 14 DIN 7993

Measures

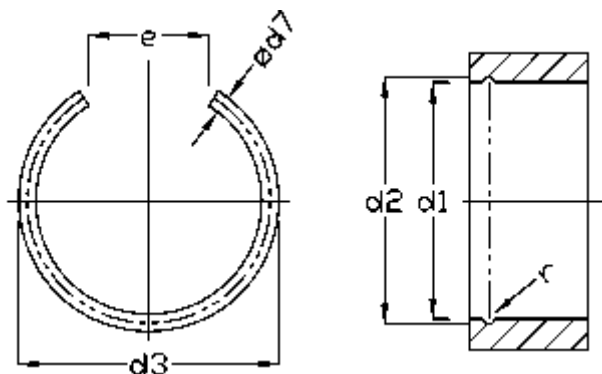

d1	= 14
d2	= 15.00
d3	= 15.2
d7	= 1.0
Description	= RB 14
e	= 6
r	= 0.6
tol	= +0,05 -0,05

tol	= 0.4
Weight kg/1000	= 0.234